

Data Sheet



Article number: 201581M625MTE1

Description: E+G Nut GN 1582-M6-25-MT-E-1
Hygienic design

Measures

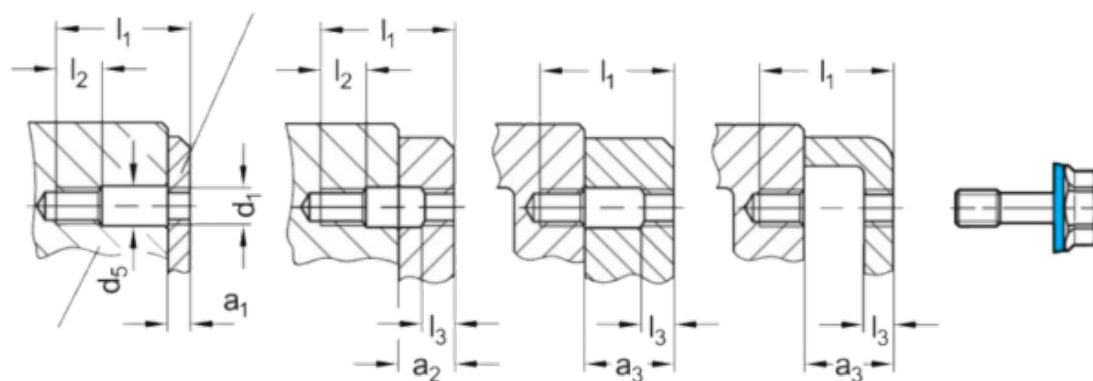
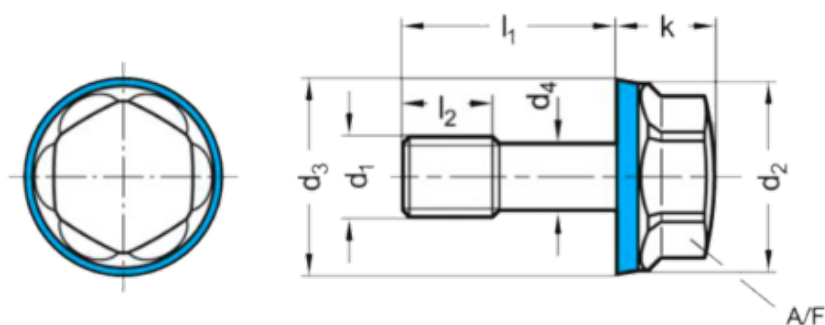

a1	= 3-7	l1	= 25
a2	= 7-13	l2	= 8
a3	= 13-17	l3	= 3
AF	= 10	Weight	= 9
d3	= 13.8		
d4 -0,2 = -			
d5	= 6.5		
k	= 7.5		